



Shimmer the Magical Touch Unicorn

model/modèle/modelo #688

For ages 1-3 years.
Pour les enfants de 1 à 3 ans.
Para 1 a 3 años de edad.



Watch Assembly Videos

Scan to find helpful assembly and troubleshooting videos or visit www.radioflyer.com/helpful-hints



Register Your Product

Scan to register this product or visit www.radioflyer.com/register for a chance to win a FREE Radio Flyer product! (One winner selected every month!)

- Thank you for your purchase. If you have any questions or comments, please visit the customer service section of our website: www.radioflyer.com
- Nous vous remercions pour votre achat. Si vous avez des questions ou des commentaires, veuillez consulter la section du service à la clientèle de notre site Web: www.radioflyer.com
- Gracias por su compra. Si tiene alguna pregunta o comentario, visite la sección de atención al cliente de nuestro sitio web: www.radioflyer.com

Or phone / ou appeler le / o llame al 1-800-621-7613

- Available weekdays 8:00 a.m. to 5:00 p.m. CST.
- Disponible en semaine de 8 h à 17 h HNC.
- Disponible en días hábiles, de 8:00 a. m. a 5:00 p. m. CST.

- Please keep this sheet for future reference.
- Veuillez conserver cette feuille pour vous y référer ultérieurement.
- Conserve esta hoja por si la necesita en el futuro.

Radio Flyer Inc. / 6515 West Grand Ave. / Chicago, IL 60707
phone: 1-800-621-7613

The Original Little Red Wagon™ - Since 1917

- Please keep these instructions for future reference.
- Veuillez conserver ces instructions pour vous y référer ultérieurement.
- Conserve estas instrucciones por si las necesita en el futuro.

3 Hardware pack:
Pack de matériel:
Paquete de tornillos:



M3.5 x10

1

- Tools Required:
- Outils nécessaires:
- Herramientas necesarias:

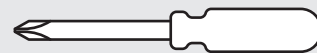

2

313614 (x1)

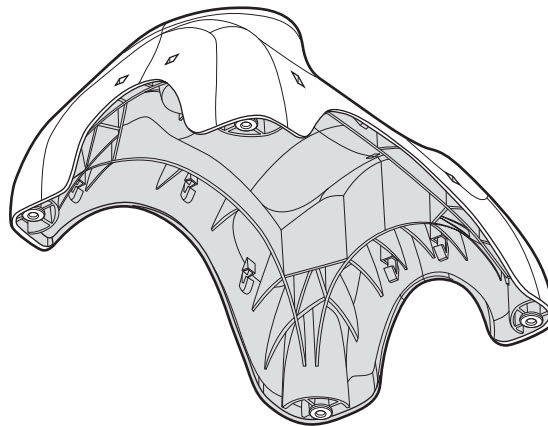

313617 (x1)

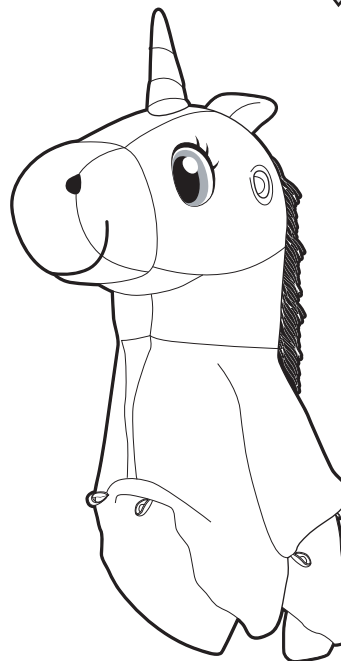

313616 (x4)

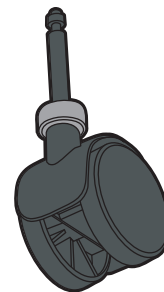

313619 (x2)

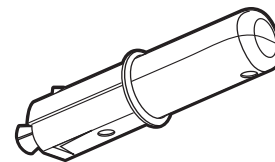

306520 (x4)

! If you find extra hardware items, please dispose of them and keep them away from small children.
Si vous avez de éléments an surplus, rangez-les dans un endroit sur, a l'abri des bambins.
Deshacerse de la ferreteria que le sobre, manteniéndolo fuera del alcance de los niños.

4

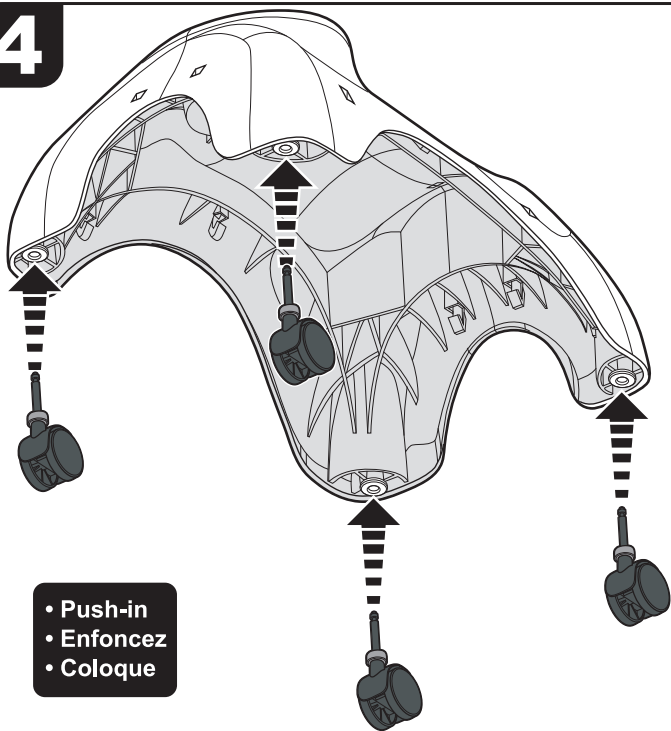

- Push-in
- Enfoncez
- Coloque

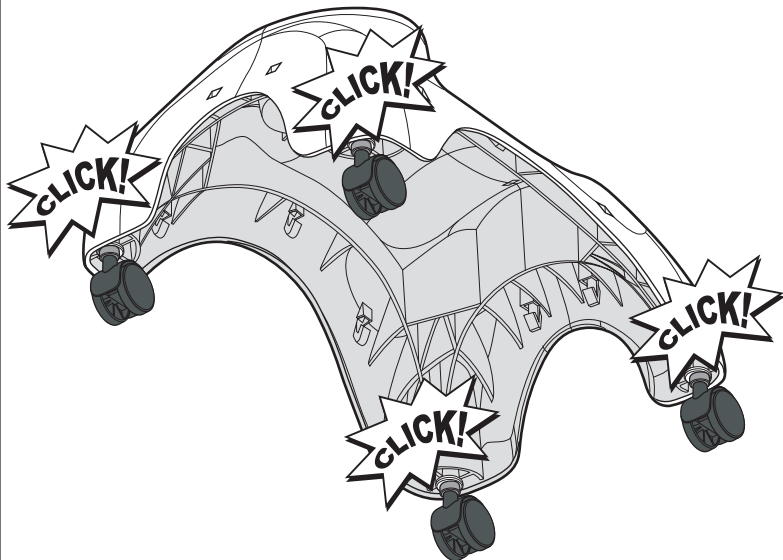

5

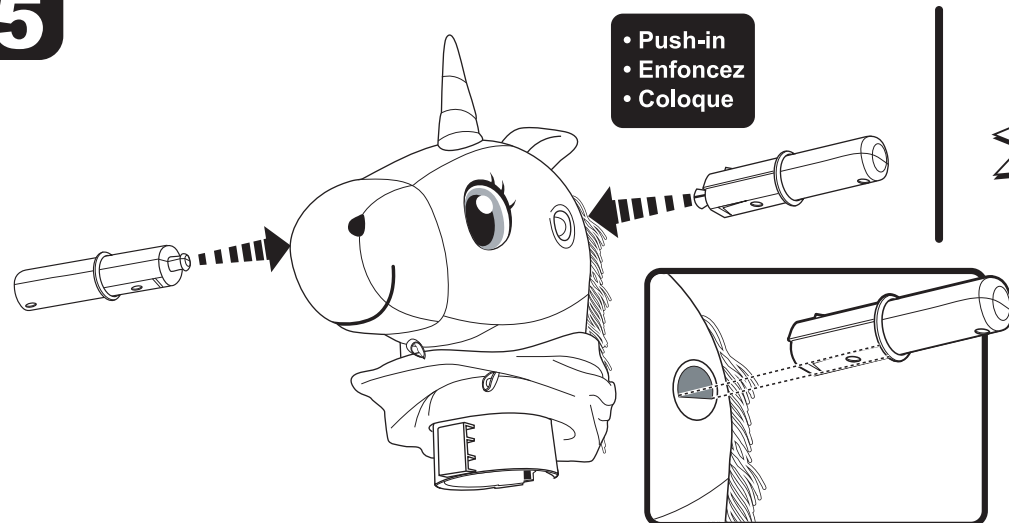

- Push-in
- Enfoncez
- Coloque



6

A

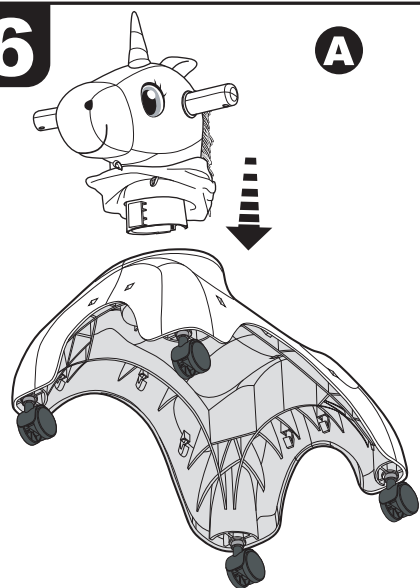

B

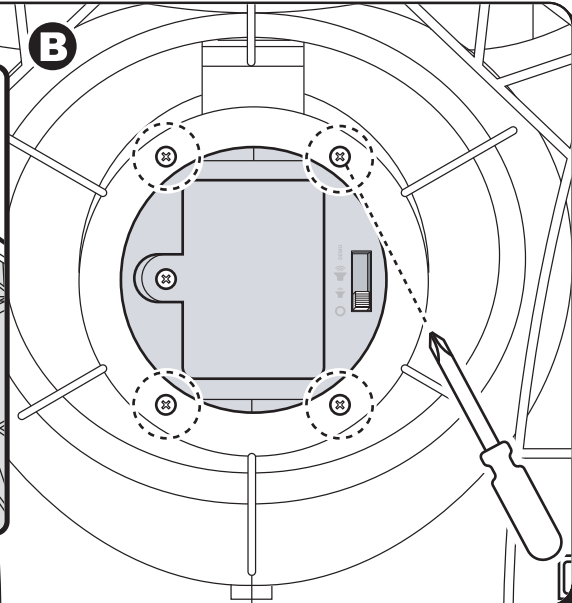
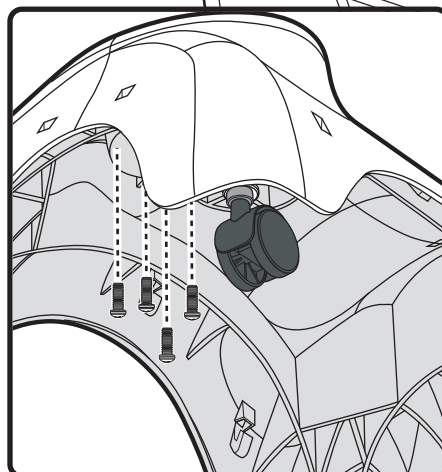

7

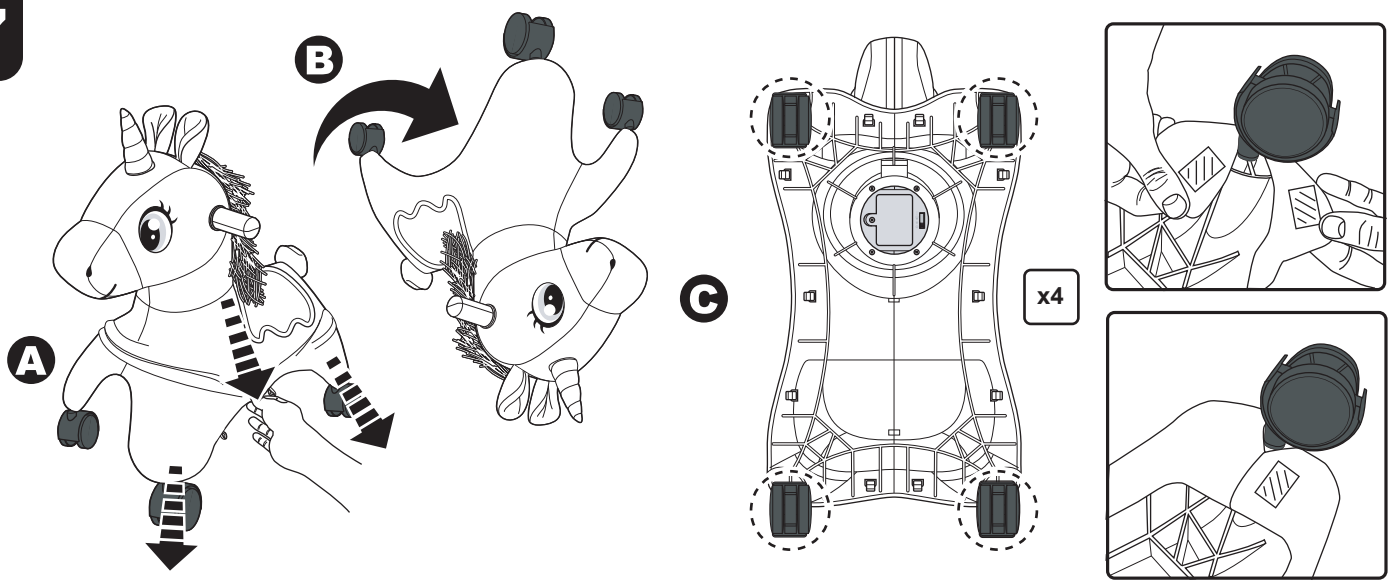

8

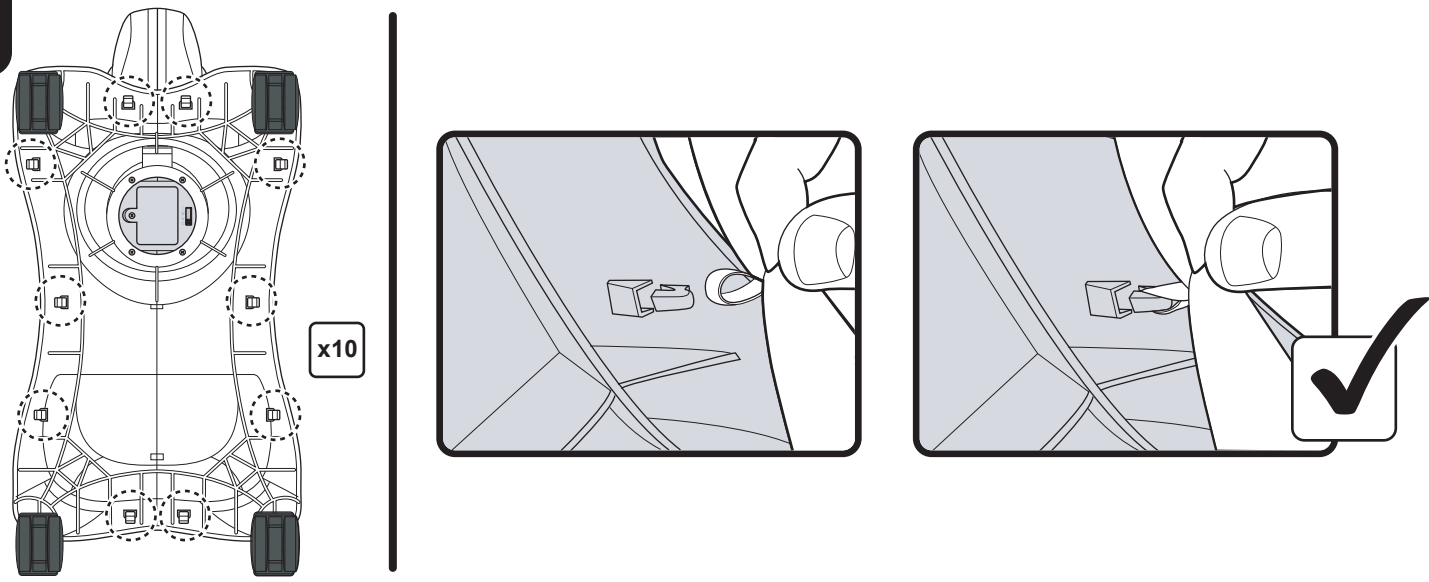

9

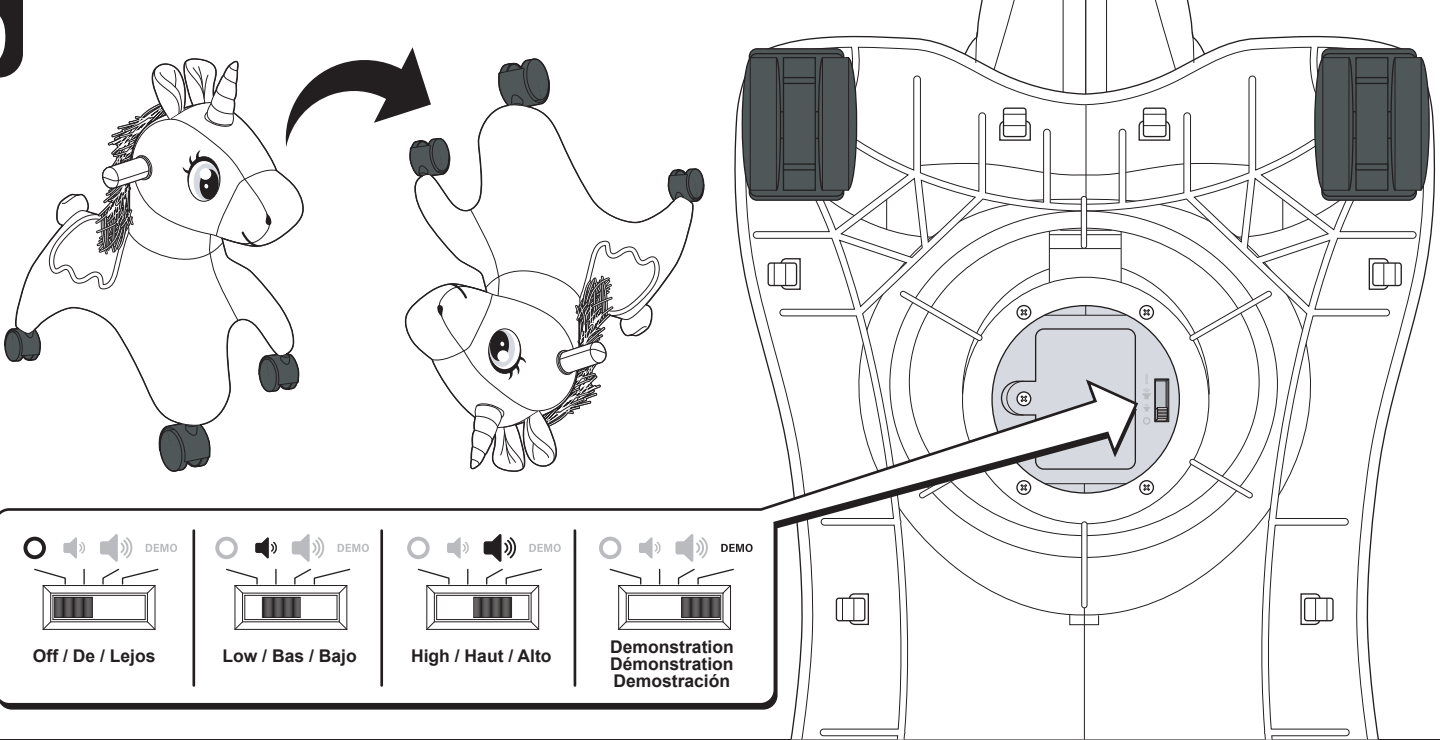

10

To activate lights and sounds:
 Pour activer les lumières et les sons:
 Para activar luces y sonidos:

A   • Pet face
 • Caresser le visage
 • Acariciar la cara

B   • Push
 • Pousser
 • Empuje

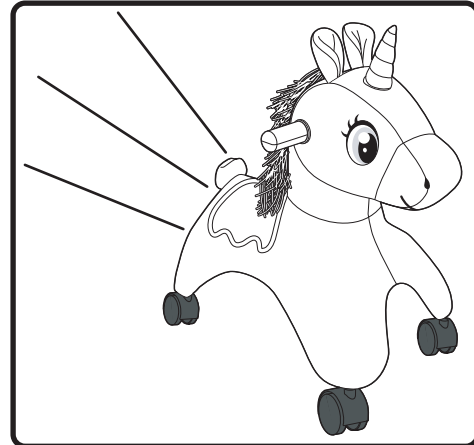
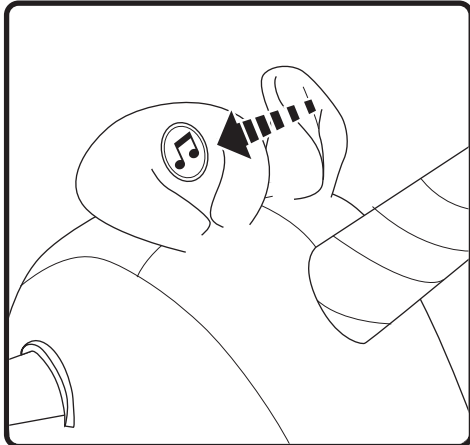
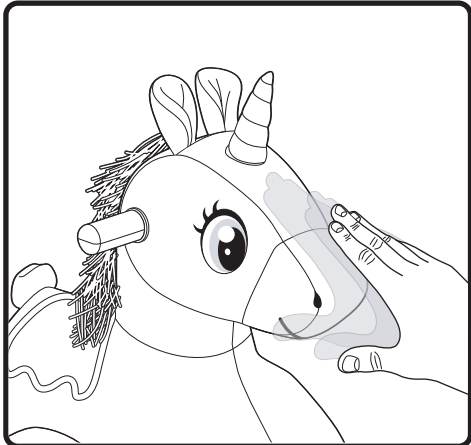

C  • Scoot
 • Déplacer
 • Mover

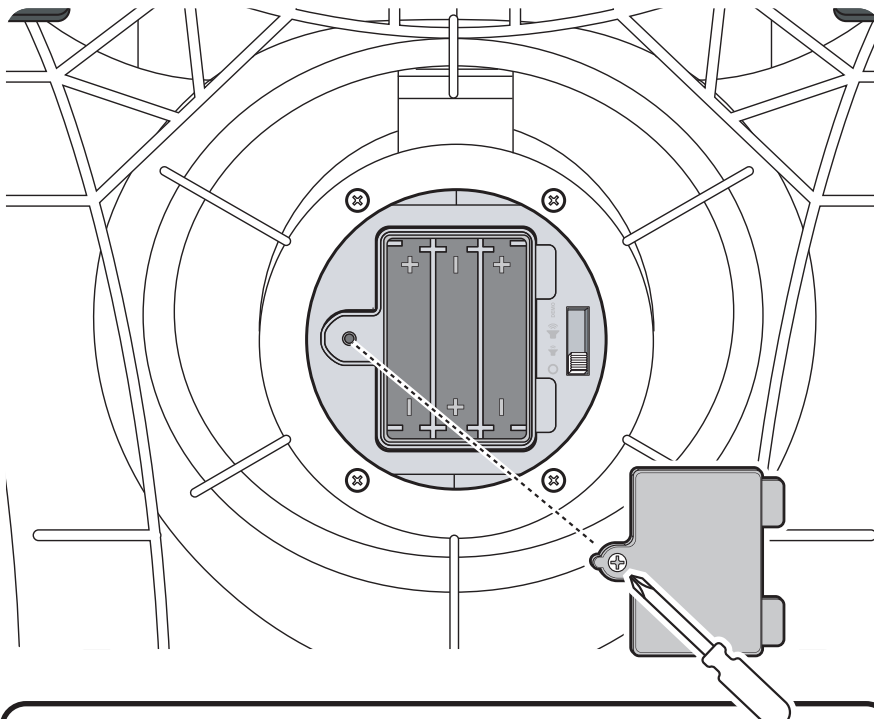

11

To replace batteries:
 Pour remplacer les piles:
 Para reemplazar las baterías:



-  Batteries to be inserted with the correct polarity.
-  Les piles être insérées avec la polarité correcte.
-  Las baterías para ser metidas con la polaridad correcta.

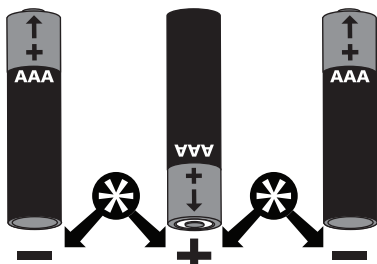

Caution : To Avoid Battery Leakage

- DO NOT mix old and new batteries.
- DO NOT mix alkaline, standard (carbon-zinc), or rechargeable (nickel-cadmium) batteries.
- DO NOT incinerate used batteries / DO NOT dispose of batteries in fire.
- DO NOT use rechargeable batteries.
- DO NOT recharge non-rechargeable batteries.
- DO NOT short-circuit the supply terminals.
- Only batteries of the same or equivalent type as recommended are to be used.
- Exhausted batteries should be removed from the toy.
- For the best performance we recommend replacing the batteries that come with the car with three new alkaline "AAA" (LR3) batteries.

Attention : Afin d'éviter tout risque de fuite des piles :

- NE PAS mélanger d'anciennes piles avec des neuves.
- NE PAS mélanger les piles alcalines, standard (carbone-zinc) ou rechargeables (nickel-cadmium).
- NE PAS incinérer les piles usagées / NE PAS jeter les piles au feu.
- NE PAS utiliser de piles rechargeables.
- NE PAS tenter de recharger des piles non rechargeables.
- NE PAS court-circuiter les bornes d'alimentation.
- Seules des piles du même type ou d'un type équivalent à celles qui sont recommandées doivent être utilisées.
- Les piles déchargées doivent être retirées du jouet.
- Pour une performance optimale, il est recommandé de remplacer les piles fournies avec la voiture par trois (3) piles alcalines AAA (LR03) neuves.

Precaución: Para evitar fugas en las pilas

- NO MEZCLE NUNCA pilas nuevas con pilas viejas.
- NO MEZCLE NUNCA pilas alcalinas, pilas normales (zinc-carbono) y pilas recargables (níquel-cadmio).
- NO INCINERE NUNCA las pilas usadas/NO TIRE NUNCA las pilas al fuego.
- NO UTILICE NUNCA pilas recargables.
- NO RECARGUE NUNCA pilas no recargables.
- NO CAUSE cortocircuitos.
- Siguiendo las recomendaciones, solo se deben utilizar pilas del mismo tipo o equivalente.
- Las pilas gastadas deben retirarse del juguete.
- Para obtener el máximo rendimiento posible, aconsejamos sustituir las pilas que incluye el producto por tres pilas nuevas alcalinas "AAA" (LR3).

• Requires 3 "AAA" (called LR03 in some countries) batteries. Install new batteries as shown in the polarity diagram(+/-) inside battery compartment.
 • Nécessite 3 piles AAA (ou LR03 selon les pays). Insérez les nouvelles piles à l'intérieur du compartiment à piles tel qu'indiqué dans le schéma de polarité (+/-).
 • Necesita 3 pilas "AAA" (llamadas LR03 en algunos países). Instale las pilas nuevas conforme se indica en el diagrama de polaridad (+/-) en el compartimento para las pilas

<p>! FCC Statement (U.S. Only)</p> <p>This device complies with Part 15 of the FCC Rules. Operation is subject to the following two conditions: (1) this device may not cause harmful interference, and (2) this device must accept any interference received, including interference that may cause undesired operation.</p> <p>Warning: Changes or modifications to this unit not expressly approved by the party responsible for compliance could void the user's authority to operate the equipment.</p> <p>Note: This equipment has been tested and found to comply with the limits for a Class B digital device, pursuant to Part 15 of the FCC Rules. These limits are designed to provide reasonable protection against harmful interference in a residential installation. This equipment generates uses and can radiate radio frequency energy and, if not installed and used in accordance with the instructions, may cause harmful interference to radio communications. However, there is no guarantee that interference will not occur in a particular installation. If this equipment does cause harmful interference to radio or television reception, which can be determined by turning the equipment off and on, the user is encouraged to try to correct the interference by one or more of the following measures:</p> <ul style="list-style-type: none"> • Reorient or relocate the receiving antenna. • Increase the separation between the equipment and receiver. • Connect the equipment into an outlet on a circuit different from that to which the receiver is connected. • Consult the dealer or an experienced radio/ TV technician for help. 	<p>Déclaration de la FCC (aux États-Unis seulement)</p> <p>Cet équipement a été déclaré conforme à la section 15 de la réglementation FCC applicable aux appareils numériques de classe B. Ces restrictions visent à garantir une protection suffisante contre les interférences nuisibles dans une installation à domicile. Cet équipement génère, utilise et peut émettre des ondes radioélectriques. Il est susceptible de créer des interférences nuisibles dans les communications radioélectriques s'il n'est pas installé ou utilisé conformément aux instructions. Cependant, l'absence d'interférences dans une installation particulière n'est pas garantie. Dans le cas où cet équipement créerait des interférences avec la réception radio ou télévisée, ce qui peut être vérifié en éteignant et en rallumant l'appareil, il est conseillé d'essayer de corriger ces interférences en appliquant une ou plusieurs des mesures suivantes :</p> <ul style="list-style-type: none"> • Réorienter ou déplacer l'antenne de réception. • Augmenter la distance entre l'équipement et le récepteur • Brancher l'appareil sur un circuit électrique différent de celui où le récepteur est branché. • Consulter le fournisseur ou un technicien radio/TV expérimenté, afin d'obtenir une assistance. <p>Note : Les changements ou les modifications non expressément approuvés par les autorités compétentes en matière de conformité peuvent priver l'utilisateur du droit d'utiliser l'équipement en question. Cet appareil est conforme à la section 15 de la réglementation FCC. Son utilisation est soumise aux deux conditions suivantes : (1) cet appareil ne doit pas causer d'interférences nuisibles, et (2) cet appareil doit accepter toute autre interférence reçue, y compris les interférences pouvant entraîner un fonctionnement non désiré, conformité peut annuler le droit de l'utilisateur à utiliser l'équipement.</p>	<p>Declaración de la FCC (únicamente para los EE. UU.)</p> <p>Este equipo ha sido probado y cumple con los límites de dispositivo digital Clase B, según la Parte 15 de las Disposiciones de la Comisión Federal de Comunicaciones (Federal Communications Commission, FCC). Estos límites están diseñados para suministrar protección razonable contra interferencias perjudiciales en una instalación residencial. Este equipo genera usos y puede irradiar energía de radiofrecuencia y, si no se instala y utiliza según las instrucciones, puede causar interferencias perjudiciales para las comunicaciones de radio. Sin embargo, no hay garantía de que la interferencia no ocurra en una instalación particular. Si este equipo no causa interferencia perjudicial para la recepción de radio o televisión, que se puede determinar si se apaga y enciende el equipo, se le aconseja al usuario que trate de corregir la interferencia a través de una o más de las siguientes medidas:</p> <ul style="list-style-type: none"> • Reorientar o volver a localizar la antena de recepción. • Aumentar la separación entre el equipo y el receptor. • Conectar el equipo en un enchufe en un circuito diferente a donde esté conectado el receptor. • Consultar al vendedor o a un técnico de radio/TV con experiencia para que lo ayude. <p>Nota: las modificaciones o los cambios no aprobados expresamente por el fabricante responsable del cumplimiento pueden anular la autoridad del usuario de utilizar el equipo. Este dispositivo cumple con la Parte 15 de las Disposiciones de la FCC. El funcionamiento está sujeto a las dos condiciones siguientes: (1) Este dispositivo no puede causar interferencia perjudicial y (2) este dispositivo debe aceptar cualquier interferencia recibida, incluso la interferencia que pueda causar un funcionamiento no deseado.</p>
-------------------------------------------------------------------------------------------------------------------------------------------------------------------------------------------------------------------------------------------------------------------------------------------------------------------------------------------------------------------------------------------------------------------------------------------------------------------------------------------------------------------------------------------------------------------------------------------------------------------------------------------------------------------------------------------------------------------------------------------------------------------------------------------------------------------------------------------------------------------------------------------------------------------------------------------------------------------------------------------------------------------------------------------------------------------------------------------------------------------------------------------------------------------------------------------------------------------------------------------------------------------------------------------------------------------------------------------------------------------------------------------------------------------------------------------------------------------------------------------------------------------------------------------------------------------------------------------------------------------------------------------------------------------------------------------------------------------------------	------------------------------------------------------------------------------------------------------------------------------------------------------------------------------------------------------------------------------------------------------------------------------------------------------------------------------------------------------------------------------------------------------------------------------------------------------------------------------------------------------------------------------------------------------------------------------------------------------------------------------------------------------------------------------------------------------------------------------------------------------------------------------------------------------------------------------------------------------------------------------------------------------------------------------------------------------------------------------------------------------------------------------------------------------------------------------------------------------------------------------------------------------------------------------------------------------------------------------------------------------------------------------------------------------------------------------------------------------------------------------------------------------------------------------------------------------------------------------------------------------------------------------------------------------------------------------------------------------------------------------------------------------------------------------------------------------------------------------------------------------------------------------------------------------------------------------------------------------------------------------------------------------------------------------------------------------------------------------------------------------	--------------------------------------------------------------------------------------------------------------------------------------------------------------------------------------------------------------------------------------------------------------------------------------------------------------------------------------------------------------------------------------------------------------------------------------------------------------------------------------------------------------------------------------------------------------------------------------------------------------------------------------------------------------------------------------------------------------------------------------------------------------------------------------------------------------------------------------------------------------------------------------------------------------------------------------------------------------------------------------------------------------------------------------------------------------------------------------------------------------------------------------------------------------------------------------------------------------------------------------------------------------------------------------------------------------------------------------------------------------------------------------------------------------------------------------------------------------------------------------------------------------------------------------------------------------------------------------------------------------------------------------------------------------------------------------------------------------------------------------------------------------------------------------------------------------------------------------------------------------------------------------------------------------------------------------------

<p>! ICES-3 Statement (Canada Only):</p> <p>CAN ICES-3 (B)/NMB-3 (B).</p>	<p>• NMB-003 déclaration (Canada seulement):</p> <p>CAN ICES-3 (B)/NMB-3 (B).</p>	<p>• Norma ICES-003 (solo para Canadá):</p> <p>CAN ICES-3 (B)/NMB-3 (B).</p>
----------------------------------------------------------------------------------	------------------------------------------------------------------------------------------	-------------------------------------------------------------------------------------

<p>⚠ WARNING: TO AVOID SERIOUS INJURY:</p> <ul style="list-style-type: none"> • Adult assembly required. • Continuous adult supervision is required. • Never use near motor vehicles, streets, roadways, alleys, swimming pool areas, hills, steps, sloped driveways, inclines and public highways. • Only one rider at a time. • Always wear shoes when using the toy. • Periodically check hardware and tighten if necessary. Replace worn or broken parts immediately. • Never ride the toy in wet weather. • Never ride the toy outside at night. • Maximum weight 42.0 lbs. (19.0 kg). • This toy is not suitable for children over 36 months due to insufficient size. • Do not allow children to stand on the product at any time. • Choking hazard to children under the age of 3 years – contains small parts prior to assembly. All fasteners should be fully tightened. 	<p>⚠ MISE EN GARDE : POUR ÉVITER LES BLESSURES GRAVES :</p> <ul style="list-style-type: none"> • Assemblage requis par adulte. • La surveillance constante d'un adulte est nécessaire. • Ne jamais utiliser à proximité de véhicules motorisés, de rues, de ruelles, de piscines, de collines, de marches, d'allées en pente, d'inclinaisons et de voies publiques. • Un seul passager à la fois. • Toujours porter des chaussures pour utiliser le jouet. • Vérifier périodiquement la visserie et serrer si nécessaire. Remplacez les pièces usées ou brisées immédiatement. • Ne jamais utiliser le jouet par temps humide. • Ne jamais utiliser le jouet dehors la nuit. • Poids maximum 19,0 kg (42,0 lbs). • Ce jouet ne convient pas aux enfants de plus de 36 mois car sa taille est insuffisante. • Ne pas laisser les enfants se tenir debout sur le produit. • Risque d'étouffement pour le enfants de moins de trois ans – Contient des pièces de petite taille avant assemblage. Toutes les attaches devraient être bien serrées. 	<p>⚠ ADVERTENCIA: PARA EVITAR LESIONES GRAVES:</p> <ul style="list-style-type: none"> • Montaje requerido por adultos. • Se requiere supervisión permanente de un adulto. • Nunca usar el producto cerca de vehículos motorizados, calles, carreteras, callejones, piscinas, colinas, escalones, caminos inclinados, pendientes o autopistas. • Solo un conductor a la vez. • Llevar siempre zapatos mientras se usa el juguete. • Revisar periódicamente las piezas y ajustarlas si fuera necesario. Reemplazar inmediatamente las piezas gastadas o rotas. • Nunca usar el juguete en lugares mojados. • Nunca usar el juguete en exteriores por la noche. • Peso máximo: 19.0 kg (42 libras). • Este juguete no es apto para niños de más de 36 meses ya que no tiene tamaño necesario. • No se debe permitir que los niños se paren sobre el producto en ningún momento. • Peligro de asfixia en niños menores de 3 años - contiene piezas pequeñas antes del montaje. Todos los seguros deben ser apretados completamente.
------------------------------------------------------------------------------------------------------------------------------------------------------------------------------------------------------------------------------------------------------------------------------------------------------------------------------------------------------------------------------------------------------------------------------------------------------------------------------------------------------------------------------------------------------------------------------------------------------------------------------------------------------------------------------------------------------------------------------------------------------------------------------------------------------------------------------------------------------------------------------------------------------------------------------------------------------------------------------------------------------------------------	------------------------------------------------------------------------------------------------------------------------------------------------------------------------------------------------------------------------------------------------------------------------------------------------------------------------------------------------------------------------------------------------------------------------------------------------------------------------------------------------------------------------------------------------------------------------------------------------------------------------------------------------------------------------------------------------------------------------------------------------------------------------------------------------------------------------------------------------------------------------------------------------------------------------------------------------------------------------------------------------------------------------------------------------------------------------------------------------------------------------------------------------------------------------------------	---------------------------------------------------------------------------------------------------------------------------------------------------------------------------------------------------------------------------------------------------------------------------------------------------------------------------------------------------------------------------------------------------------------------------------------------------------------------------------------------------------------------------------------------------------------------------------------------------------------------------------------------------------------------------------------------------------------------------------------------------------------------------------------------------------------------------------------------------------------------------------------------------------------------------------------------------------------------------------------------------------------------------------------------------------------------------------------------------------------------------------------------------------------------